

Heat Pump Datasheet

Models:	EMT-1230-1-4-ECO	EMT-1230-1-7-ECO
Refrigerant:	R1234ze	R515B
Certification:	CE	CE
Safety class:	A2L	A1

This Energy Machines™ EMT model contains a refrigerant circuit with an oil-free centrifugal turbocompressor. It is classified as a non-positive displacement compressor.

This model is equipped with an economizer heat exchanger, increasing its energy efficiency. The machine's evaporator and condenser are shell-and-tube heat exchangers. The evaporator operates with a flooded evaporation technique.

These components work together to create a powerful and efficient machine.

The heat pump is available with or without the outer casing.



Characteristics

Model characteristics	
Energy source	Ground, water, or waste heat
Compressor type	Turbo
Capacity control	Frequency controlled
Special features	Economizer, oil-free
Options	Available with or without outer casing

Performance

Heating mode	
Heating capacity (kW)	265
Cooling capacity (kW)	205
COP	4.33

Cooling mode	
Heating capacity (kW)	290
Cooling capacity (kW)	235
COP	4.04

COP = Coefficient of performance

Design temperatures

Heating mode	
Heated fluid (in/out)	47°C / 53°C
Chilled fluid (in/out)	12°C / 7°C

Cooling mode	
Heated fluid (in/out)	37°C / 43°C
Chilled fluid (in/out)	12°C / 7°C

Chilled fluid = water, Heated fluid = water

Flow and pressure drop

Heating mode		
	Heated fluid	Chilled fluid
Flow (l/s)	10.55	9.79
Pressure drop (kPa)	17.2	22.4

Cooling mode		
	Heated fluid	Chilled fluid
Flow (l/s)	11.55	11.23
Pressure drop (kPa)	20.7	29.3

Chilled fluid = water, Heated fluid = water

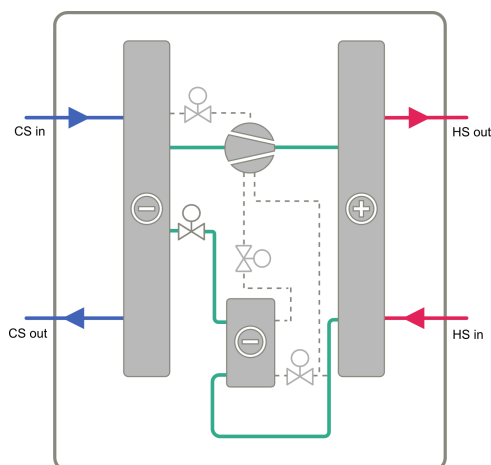

Specifications

Electricity	
Power supply voltage (VAC)	400
Power supply frequency (Hz)	50
Power supply phase (ϕ)	3
Rated power input (kW)	66
Rated current (A)	106
Fuse (A)	125

Dimensions*	
Length (mm)	2950
Width (mm)	1210
Height (mm)	1945
Dry weight (kg)	1900
Commissioned weight (kg)	2300
*See dimensional drawings for clearance requirements	

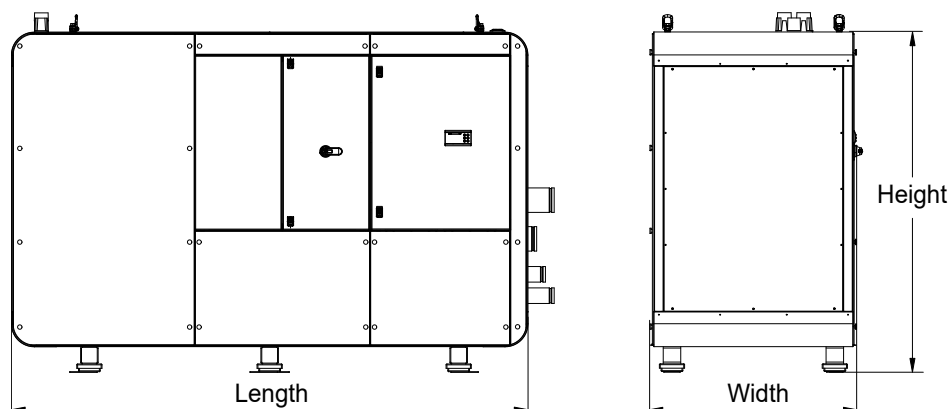

Refrigerant		
Model	EMT-1230-1-4-ECO	EMT-1230-1-7-ECO
Type	R1234ze	R515B
GWP value	1.37	288
Charge (kg)		N/A

Energy Machines has a policy of continuous product and data improvement and reserves the right to change design and specifications without notice. While Energy Machines strives for accuracy, it does not guarantee the completeness or correctness of the information provided.



Energy Machines ApS Denmark Nicolai Eigtveds Gade 26, 1402 Copenhagen | Niels Jernes Vej 14, 9220 Aalborg Ø
Energy Machines Oy Finland Emäsalontie 271, 06950 Emäsalo Energy Machines Inc. USA 110 East 25th Street, New York, NY 10010
Energy Machines AB Sweden Norra Skeppsbron 15, 803 10 Gävle | Regnbågsgatan 3, 417 55 Gothenburg
Mariehällsvägen 37 F, 168 65 Bromma | Hyllie Boulevard 34, 21532 Malmö
hello@energymachines.com | energymachines.com