

EMT heat pump

Datasheet

EMT-4380-1-4-FT (R1234ze)

EMT-4380-1-7-FT (R515B)

This Energy Machines™ model contains four oil-free centrifugal turbocompressors and one refrigerant circuit. The compressors are classified as non-positive displacement compressors.

This model is equipped with a flash tank, increasing its energy efficiency. The machine's evaporator and condenser are shell-and-tube heat exchangers. The evaporator operates with a flooded evaporation technique.

These components work together to create a powerful and efficient machine.



Performance

Winter (Heating mode)		Summer (Cooling mode)	
Heating power	1902 kW	Heating power	1964 kW
Cooling power	1392 kW	Cooling power	1552 kW
COP	3.73	COP	3.77

COP = Coefficient of performance

Design parameters

Winter (Heating mode)		Summer (Cooling mode)	
Heated fluid (in/out)	57°C / 63°C	Heated fluid (in/out)	37°C / 43°C
Chilled fluid (in/out)	12°C / 7°C	Chilled fluid (in/out)	12°C / 7°C

Chilled fluid= water, Heated fluid= water.

Pressure drop at rated flow

Winter (Heating mode)		Summer (Cooling mode)	
Heated fluid	37.8 kPa / 75.73 l/s	Heated fluid	42.7 kPa / 78.2 l/s
Chilled fluid	16.2 kPa / 66.51 l/s	Chilled fluid	20.1 kPa / 74.15 l/s

Flow diagram

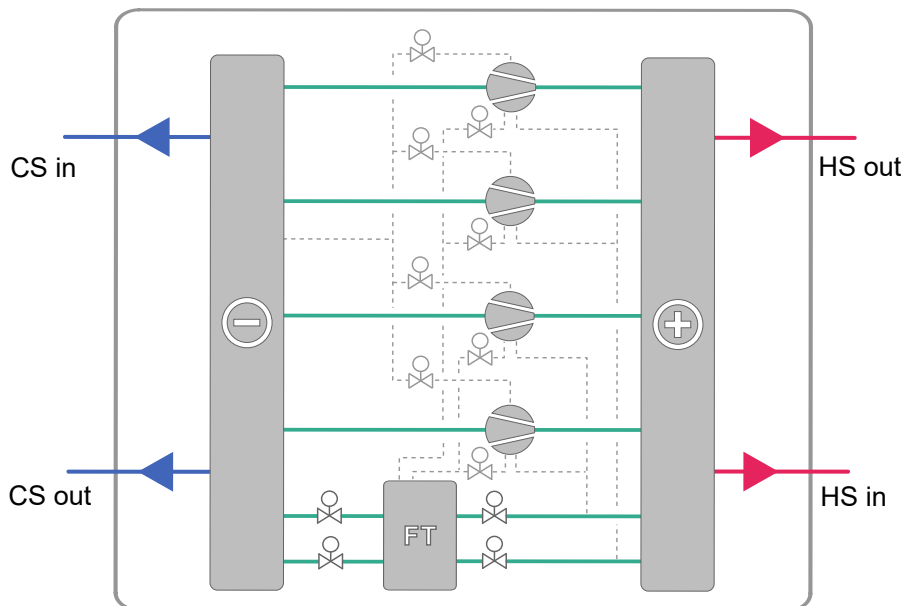

Specifications

Refrigerant			Dimensions	
Type	R1234ze	R515B	Length / Width / Height	N/Amm / N/Amm / N/Amm
GWP value	1.37	288	Weight (dry/comm.)	~ N/A kg / N/A kg
Charge	N/A kg			

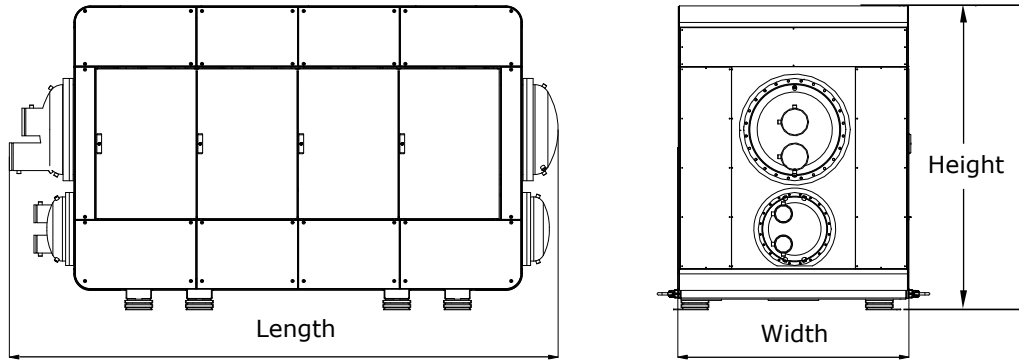

Electricity	
Rated power supply	400 VAC / 50 Hz / 3 phase
Rated power input	520 kW
Rated current	840 A
Fuse	1000 A

Energy Machines has a policy of continuous product and data improvement and reserves the right to change design and specifications without notice. While Energy Machines strives for accuracy, we do not guarantee the completeness or correctness of the information

